



**PETROMETALIC**

Solutions de régulation des fluides

High Pressure Equipment  
3 - High Pressure Valves, Fittings and Tubing  
30,000, 40,000 and 60,000 psi service



Petrometallic SA

32, rue de l'Ermitage

78000 VERSAILLES

[www.petrometallic.com](http://www.petrometallic.com)

[packers@petrometallic.com](mailto:packers@petrometallic.com)

# TABLE OF CONTENTS

General Information.....	2
High Pressure Valves, Fittings & Tubing .....	7
30,000 psi Valves .....	8
40,000 psi Valves .....	10
60,000 psi Valves .....	12
Fittings.....	14
Unions, Bulkheads & Caps.....	15
Line Filters & Check Valves .....	16
Rupture Discs.....	17
Safety Heads.....	18
Anti-Vibration Gland Assemblies.....	19
Tubing.....	20
Coned & Threaded Nipples .....	20
Connection Details .....	21



## **PETROMETALIC Siège social**

32 rue de l'Ermitage  
78000 Versailles Cedex  
Tél : 33 (0)1 39 23 96 70  
Fax : 33 (0)1 39 23 96 71  
PDG : M. Philippe Mazurel  
direction@petrometalic.com



## **PETROMETALIC Cambrai**

11 rue de Ecluses de Selles BP 287  
59400 Cambrai cedex  
Tél : 33 (0) 3 27 72 06 60  
Fax : 33 (0) 3 27 72 06 61  
DAF : Geneviève Leroy  
daf@petrometalic.com

## **CONTACTS :**

Mme Elisabeth BONNEVILLE  
Commercial France / Export  
Tél. +33 3 27 72 06 24  
Fax +33 3 27 72 06 31  
packers@petrometalic.com

Mr Didier RENU  
Responsable Commercial  
Tél. +33 3 27 72 06 20  
Fax +33 3 27 72 06 31  
packers@petrometalic.com

# DÉPARTEMENT ACTIVITÉS SPÉCIFIQUES, TP ET INDUSTRIE

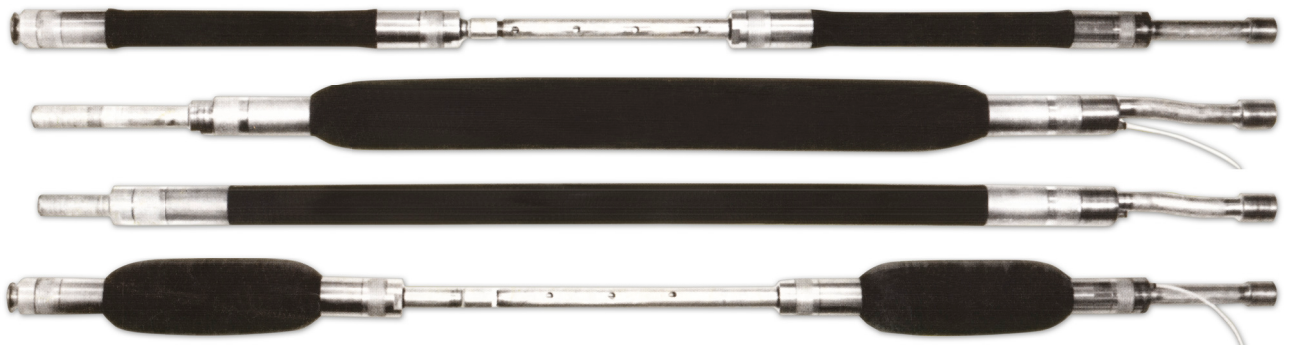

## OBTURATEURS BIMBAR / PACKERS

Petrometalic développe et exporte dans le monde entier depuis 1975 le tuyau dilatable BIMBAR, d'abord pour l'abattage hydraulique du charbon, ensuite pour la consolidation des sols et les applications géotechniques.

📄 plus d'information sur les obturateurs sur [Petrometalic.com](http://Petrometalic.com)



Surpresseur de chantier SP400 - 90 à 490 bar



Pompe HP Le Touquet - 210 à 2100 bar

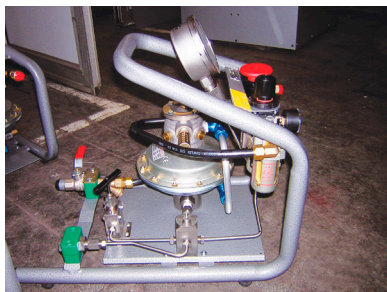

Surpresseur SP2300 - 10 à 2330 bar

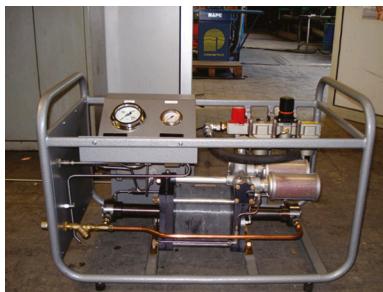

Pompe gros débit S218GJC - jusqu'à 1380 bar

## POMPES ET SURPRESSEURS

Surpresseurs nus ou équipés en centrale jusqu'à 3000 bars.

- ▶ Types
  - surpresseurs hydropneumatiques
  - surpresseurs à gaz
  - surpresseurs d'injection ciment ou résine
  - surpresseurs de chantier
  - pompes manuelles

- ▶ Domaines
  - TP
  - offshore
  - industrie
  - géotechnologie

📄 catalogue surpresseurs et pompes téléchargeables sur [Petrometalic.com](http://Petrometalic.com)

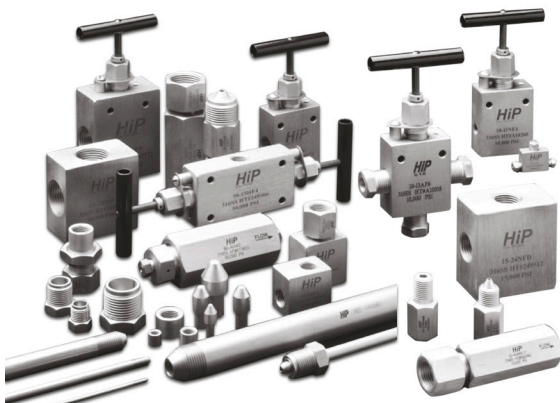

## RACCORDS ET TUBES TRÈS HAUTE PRESSION

Une gamme HP et THP couvrant tous les composants consultables et téléchargeables dans nos catalogues.

📄 catalogues THP téléchargeables sur [Petrometalic.com](http://Petrometalic.com)

## SERVICE COMMERCIAL

email : [packers@petrometalic.com](mailto:packers@petrometalic.com)  
tel. : +33 3 27 72 06 24 (Cambrai)  
tel. : +33 3 27 72 06 20 (Cambrai)

## NOS ENGAGEMENTS

- ✓ un stock de 1.1M€
- ✓ 50 ans d'expérience
- ✓ conseil de qualité

# Valve Design

## General

- Valve bodies through 100,000 psi are high tensile Type 316 stainless steel, 150,000 psi valve bodies are 17-4 PH stainless steel.
- Stem assemblies have non-rotating tips to prevent galling with valve seats.
- Packing is located below the stem threads to prevent contact with media (liquid or gas).
- Packing glands are equipped with locking devices or lock nuts.
- Six valve patterns (see chart on page 1.3).
- Tubing connections are:  $\frac{1}{16}$ " ,  $\frac{1}{8}$ " ,  $\frac{1}{4}$ " ,  $\frac{3}{8}$ " ,  $\frac{9}{16}$ " ,  $\frac{3}{4}$ " , and 1". Pipe connections include:  $\frac{1}{8}$ " ,  $\frac{1}{4}$ " ,  $\frac{3}{8}$ " ,  $\frac{1}{2}$ " ,  $\frac{3}{4}$ " , and 1" NPT.
- Remote control air operators are available for most valves.

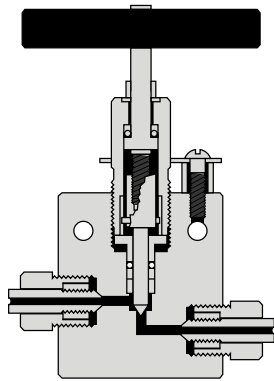

Positive Guide Stem

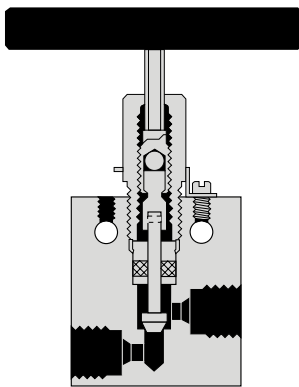

Pinned Stem

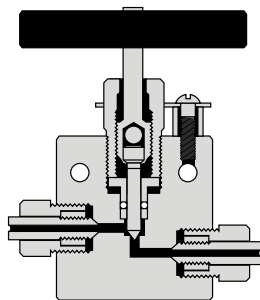

Rolled Style Stem

**Positive Guide Stem:** High Pressure Equipment Company's patented "Positive Guide" stem assembly virtually eliminates lower stem rotation — one of the most common causes of premature stem failure. The lower section stem is manufactured from hardened 17-4 PH stainless steel for exceptional wear and corrosion resistance and can be easily serviced with no special tooling required. The one-piece upper section stem eliminates the need for continual adjustment and minimizes "loose handle" backlash.

The Positive Guide Stem is standard for all AF4, AF6, HF4, HF6, and HF9 valves, and 60,000 psi HF2 valves.

**Rolled Style Stem:** This simple two-piece design is also non-rotating and is ideal for smaller valves and for valves made from exotic materials. The standard lower section stem is manufactured from hardened 17-4 PH stainless steel. It is affixed to a one-piece upper stem requiring no periodic adjustment. The two stem components are free to rotate independently of each other, thereby minimizing rotation of the lower stem against the valve seat.

The Rolled Style Stem is standard for all AF1, AF2, NFA, NFB, LF4, LF6 valves, 30,000 psi HF2, XF4, and XF6 valves, as well as most valves requiring stems made from exotic materials. It is optional for any valve normally supplied with a Positive Guide Stem.

**Pinned Stem Design:** This variation on the Rolled Style Stem is a three-piece design in which the lower stem is pinned into a freely-rotating stem guide. It has all of the advantages of the rolled style stem, with the additional benefit of a replaceable lower section stem.

The Pinned Stem Design is standard for all NFC, NFD, NFF, NFH, LF9, LF12, LF16, and HF16 valves.

# Quick Selector Guide to Standard Valves

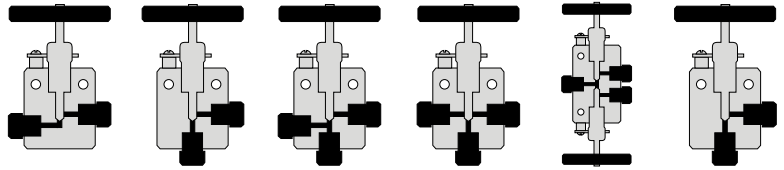

## Taper Seal Valves

	Tubing Size		Two Way Straight	Two Way Angle	Three Way Two Press	Three Way One Press	Three Way Two Stem	Replaceable Seat
	O.D.	I.D.						
10,000 psi	1/4"	1/8"	10-11AF4	10-12AF4	10-13AF4	10-14AF4	10-15AF4	NA
	3/8"	1/4"	10-11AF6	10-12AF6	10-13AF6	10-14AF6	10-15AF6	NA
15,000 psi	1/16"	.030"	15-11AF1	15-12AF1	15-13AF1	15-14AF1	15-15AF1	NA
	1/8"	1/16"	15-11AF2	15-12AF2	15-13AF2	15-14AF2	15-15AF2	NA
20,000 psi	1/4"	7/64"	20-11LF4	20-12LF4	20-13LF4	20-14LF4	20-15LF4	20-12LF4R
	3/8"	19/64"	20-11LF6	20-12LF6	20-13LF6	20-14LF6	20-15LF6	20-12LF6R
	9/16"	5/16"	20-11LF9	20-12LF9	20-13LF9	20-14LF9	20-15LF9	20-12LF9R
	3/4"	33/64"	20-11LF12	20-12LF12	20-13LF12	20-14LF12	20-15LF12	20-12LF12R
	1"	11/16"	20-11LF16	20-12LF16	20-13LF16	20-14LF16	20-15LF16	20-12LF16R
30,000 psi	1/8"	.040"	30-11HF2	30-12HF2	30-13HF2	30-14HF2	30-15HF2	30-12HF2R
	1/4"	.083"	30-11HF4	30-12HF4	30-13HF4	30-14HF4	30-15HF4	30-12HF4R
	3/8"	1/8"	30-11HF6	30-12HF6	30-13HF6	30-14HF6	30-15HF6	30-12HF6R
	9/16"	3/16"	30-11HF9	30-12HF9	30-13HF9	30-14HF9	30-15HF9	30-12HF9R
60,000 psi	1/8"	.020"	60-11HF2	60-12HF2	60-13HF2	60-14HF2	60-15HF2	60-12HF2R
	1/4"	1/16"	60-11HF4	60-12HF4	60-13HF4	60-14HF4	60-15HF4	60-12HF4R
	3/8"	1/8"	60-11HF6	60-12HF6	60-13HF6	60-14HF6	60-15HF6	60-12HF6R
	9/16"	3/16"	60-11HF9	60-12HF9	60-13HF9	60-14HF9	60-15HF9	60-12HF9R
100,000 psi	1/4"	1/16"	100-11XF4	100-12XF4	100-13XF4	100-14XF4	NA	100-12XF4R
150,000 psi	3/8"	1/16"	150-11XF6	150-12XF6	150-13XF6	150-14XF6	NA	150-12XF6R

## Medium Pressure Valves

## High Pressure Valves

## Ultra High Pressure Valves



# High Pressure Equipment

## Catalog Numbering System

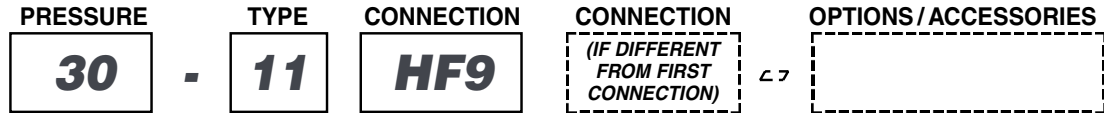

### Pressure Series

- 10 = 10,000 psi
- 15 = 15,000 psi
- 20 = 20,000 psi
- 30 = 30,000 psi
- 40 = 40,000 psi
- 60 = 60,000 psi
- 100 = 100,000 psi
- 150 = 150,000 psi

Catalog part numbers for some components (NPT fittings, special alloy parts) have been maintained for historical consideration.

The referred pressure series may not reflect the actual pressure rating. Please refer to applicable catalog page for pressure rating, or consult the factory.

### Type of Components

- 2 = Gland, Collar or Sleeve
- 3 = Anti-Vibration Assembly
- 7 = Plug
- 11 = 2-Way Straight Valve
- 12 = 2-Way Angle Valve
- 13 = 3-Way Valve with Two Pressure Connections
- 14 = 3-Way Valve with One Pressure Connections
- 15 = 3-Way, 2-Stem Valve
- 16 = Ball Valve (Floating)
- 21 = Coupling or Adapter
- 22 = Elbow
- 23 = Tee
- 24 = Cross
- 41 = Check Valve
- 51 = Line Filter
- 61 = Safety Head (Straight)
- 63 = Safety Head (Tee Type)
- 71 = 2-Way Ball Valve \*
- 72 = 3-Way Ball Valve 180° \*
- 73 = 3-Way Ball Valve Diverter \*
- 74 = 2-Way Ball Valve \*
- 75 = 3-Way Ball Valve 180° \*
- 76 = 3-Way Ball Valve Diverter \*
- 77 = 3-Way Mini Ball Valve 1/4" NPT
- 80 = 2-Way Ball Valve \*
- 81 = 3-Way Ball Valve 180° \*
- 82 = 3-Way Ball Valve Diverter \*

\* (Trunion)

### Connection(s) Size and Type

Female	Male	
AF1	AM1	1/16" Taper Seal
AF2	AM2	1/8" Taper Seal
AF4	AM4	1/4" Taper Seal
AF6	AM6	3/8" Taper Seal
LF4	LM4	1/4" Medium Pressure
LF6	LM6	3/8" Medium Pressure
LF9	LM9	9/16" Medium Pressure
LF12	LM12	3/4" Medium Pressure
LF16	LM16	1" Medium Pressure
HF2	HM2	1/8" High Pressure
HF4	HM4	1/4" High Pressure
HF6	HM6	3/8" High Pressure
HF9	HM9	9/16" High Pressure
HF16	HM16	1" High Pressure
XF4	XM4	1/4" Ultra High Pressure
XF6	XM6	3/8" Ultra High Pressure
NFA	NMA	1/8" NPT Pipe
NFB	NMB	1/4" NPT Pipe
NFC	NMC	3/8" NPT Pipe
NFD	NMD	1/2" NPT Pipe
NFF	NMF	3/4" NPT Pipe
NFH	NMH	1" NPT Pipe
—	HA9	9/16" Hose
—	HA12	3/4" Hose
—	HA16	1" Hose
—	HA21	1 5/16" Hose

### Options

- V = Micro Control Metering Assembly (See page 6.5)
- HT = High Temperature Stem Extension (Up to 1,000° F) (See page 6.4)
- SGS = Sour Gas (H<sub>2</sub>S) Service
- N/O = Normally Open
- N/C = Normally Closed
- K = With Antivibration Collars and Glands
- REG = Regulating Tip
- TSR8 = Ball Valve Actuator
- TDA8 = Ball Valve Actuator Double Acting
- W/O = Without Collars and Glands
- LT = Low Temperature Stem Extension (to -320°F)
- MPO-NO = Medium Duty Piston Operator Normally Open
- MPO-NC = Medium Duty Piston Operator Normally Closed
- HPO-NO = Heavy Duty Piston Operator Normally Open
- HPO-NC = Heavy Duty Piston Operator Normally Closed
- EHPO-NO = Extra Heavy Piston Operator Normally Open
- EHPO-NC = Extra Heavy Piston Operator Normally Closed

## How to Order Valves and Fittings

Simply indicate catalog number and specify option or special requirement.

### Examples:

30-11HF4 = 30,000 psi Straight Valve for 1/4" O.D. tubing

60-23HF4 = 60,000 psi Tee for 1/4" O.D. tubing

15-21AF2 = 15,000 psi Straight Coupling for 1/8" O.D. tubing, Taper Seal connections

15-21AF2NMB = 15,000 psi Adapter with one end 1/8" O.D. Female Taper Seal and opposite end Male 1/4" NPT Pipe

30-11HF6-HT = 30,000 psi Straight Valve for 3/8" O.D. tubing with High Temperature Extension

"HIPCO" 10-12NFB (N/C) = 10,000 psi Angle Valve for 1/4" NPT Pipe with "Hipco" Air Operator, Normally Closed

"HIPPO" 15-11A4F (N/C) = 10,000 psi Angle Valve for 1/4" Taper Seal with "Hippo" Piston Operator, Normally Closed

60-21HF4 (Hastelloy C-276) = 60,000 psi Straight Coupling for 1/4" O.D. tubing, made from Hastelloy C-276 material



## **Warranty**

*High Pressure Equipment Company warrants the products which it manufactures to be free from defects in material and workmanship which would impair their intended usefulness. This warranty is for a period of one year after the date of shipment. Warranty is limited to the repair or replacement of any item manufactured by High Pressure Equipment Company. High Pressure Equipment Company shall not be liable for any direct or indirect consequential damage arising from a failure or malfunction of the equipment. This warranty further excludes damage, failure or malfunction which is caused by corrosion or erosion common to the material supplied.*

*Terms: Net 30 for qualified accounts*

*FOB: Erie, PA - USA*



## High Pressure Equipment

### High Pressure Valves, Fittings and Tubing

30,000, 40,000 and 60,000 psi service

High Pressure Equipment Company has developed a line of High Pressure products to assure safe and easy plumbing for 30,000, 40,000 and 60,000 psi. These needle valves, fittings, line filters, check valves, safety heads, rupture discs, anti-vibration gland assemblies, tubing and nipples are engineered to the highest standards of repeatable quality. The reliable performance of these products has made HiP one of the world's leading suppliers of elevated pressure components.

High Pressure components use a coned-and-threaded connection which accommodates the high temperatures and pressures common in these applications. High Pressure valves are available in various tubing sizes and with body designs to satisfy widely varied requirements. A line of fittings is available to facilitate adapting to Taper Seal, Medium Pressure, or other High Pressure threaded pipe systems.



#### Index

30,000 psi Valves.....	8
40,000 psi Valves.....	10
60,000 psi Valves.....	12
Fittings.....	14
Unions, Bulkheads & Caps.....	15
Line Filters & Check Valves.....	16
Rupture Discs.....	17
Safety Heads.....	18
Anti-Vibration Gland Assemblies.....	19
Tubing.....	20
Coned & Threaded Nipples.....	20
Connection Details.....	21



# High Pressure Equipment

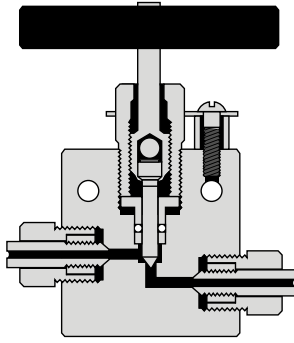

HF2 ( $\frac{1}{8}$ " )

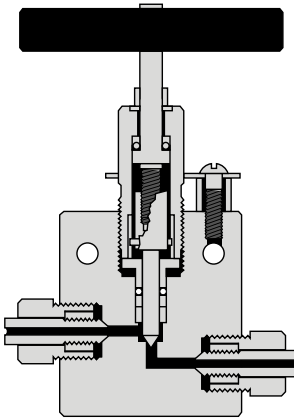

HF4 ( $\frac{1}{4}$ " ), HF6 ( $\frac{3}{8}$ " ) and HF9 ( $\frac{9}{16}$ " )

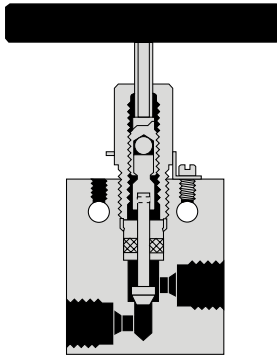

HF16 (1" )

## 30,000 psi High Pressure Valves

**High Pressure (coned & threaded)** type connections for  $\frac{1}{8}$ ",  $\frac{1}{4}$ ",  $\frac{3}{8}$ ",  $\frac{9}{16}$ " and 1" O.D. tubing.

**Non-rotating tip stems** are standard for on-off service and insure long life on valve seats. Regulating tip stems are available for all valves at no additional cost, add - REG to part number.

**Glands and collars** for tubing are supplied with each valve unless otherwise requested (glands and collars shown on pages 4.6 and 4.A).

**Materials** include high tensile type 316 stainless steel bodies and hardened 17-4PH stainless steel lower section stems.

**Packing** is Teflon (450°F) standard with optional Viton (350°F), BUNA-N (200°F) and Grafoil (800°F) available at no additional cost.

**Air operators** for remote control operation are available for all valves. (Select required valve and add "HIPCO". Refer to section 7.0 for additional data).

**High temperatures** can be accommodated using extended stuffing boxes (see page 6.6). These are available for all sizes except  $\frac{1}{8}$ " tubing. To order, add suffix -HT to standard valve catalog number.

### Valve Features

- Non-rotating stem tips
- Packing below stem threads
- Type 316 ss high tensile bodies
- Positive gland lock device
- No stem adjustment needed
- Black T-handles or choice of 4 colors
- Tube sizes  $\frac{1}{8}$ " through  $\frac{9}{16}$ "

# 30,000 psi High Pressure Valves

## Two Way Straight Valves

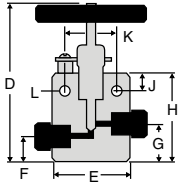

Tubing	Catalog No.	psi	Connection	Orifice	D	E	F	G	H	J	K	L	Thickness
1/8" O.D.	30-11HF2	30,000	HF2	1/16"	3 1/4"	1 1/2"	1 1/16"	1 5/16"	1 13/16"	5/16"	7/8"	9/64"	3/4"
1/4" O.D.	30-11HF4	30,000	HF4	3/32"	5 3/16"	2"	5/8"	1"	2 7/16"	1/2"	1 3/8"	7/32"	1"
3/8" O.D.	30-11HF6	30,000	HF6	1/8"	5 9/16"	2"	5/8"	1"	2 7/16"	1/2"	1 3/8"	7/32"	1"
9/16" O.D.	30-11HF9	30,000	HF9	1/8"	5 5/8"	2 5/8"	1"	1 7/16"	2 7/8"	1/2"	1 3/8"	7/32"	1 1/2"
1" O.D.	30-11HF16	30,000	HF16	7/16"	8 27/64"	4 1/8"	1 5/16"	1 11/16"	4 7/16"	1 1/8"	2 1/2"	9/16"	1 3/4"

## Two Way Angle Valves

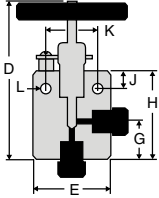

Tubing	Catalog No.	psi	Connection	Orifice	D	E	F	G	H	J	K	L	Thickness
1/8" O.D.	30-12HF2	30,000	HF2	1/16"	3 1/4"	1 1/2"	—	1 5/16"	1 13/16"	5/16"	7/8"	9/64"	3/4"
1/4" O.D.	30-12HF4	30,000	HF4	3/32"	5 3/16"	2"	—	1"	2 7/16"	1/2"	1 3/8"	7/32"	1"
3/8" O.D.	30-12HF6	30,000	HF6	1/8"	5 9/16"	2"	—	1 3/8"	2 13/16"	1/2"	1 3/8"	7/32"	1"
9/16" O.D.	30-12HF9	30,000	HF9	1/8"	5 5/8"	2 5/8"	—	1 7/16"	2 7/8"	1/2"	1 3/8"	7/32"	1 1/2"
1" O.D.	30-12HF16	30,000	HF16	7/16"	9 1/32"	4 1/8"	—	2 3/8"	5 1/8"	1 1/8"	2 1/2"	9/16"	1 3/4"

## Three Way Valves / Two Pressure Connections

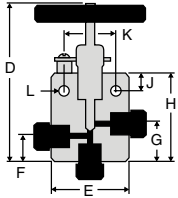

Tubing	Catalog No.	psi	Connection	Orifice	D	E	F	G	H	J	K	L	Thickness
1/8" O.D.	30-13HF2	30,000	HF2	1/16"	3 1/4"	1 1/2"	1 1/16"	1 5/16"	1 13/16"	5/16"	7/8"	9/64"	3/4"
1/4" O.D.	30-13HF4	30,000	HF4	3/32"	5 3/16"	2"	5/8"	1"	2 7/16"	1/2"	1 3/8"	7/32"	1"
3/8" O.D.	30-13HF6	30,000	HF6	1/8"	5 9/16"	2"	1"	1 3/8"	2 13/16"	1/2"	1 3/8"	7/32"	1"
9/16" O.D.	30-13HF9	30,000	HF9	1/8"	6 1/16"	2 5/8"	1 7/16"	1 7/8"	3 5/16"	1/2"	1 3/8"	7/32"	1 1/2"
1" O.D.	30-13HF16	30,000	HF16	7/16"	9 23/32"	4 1/8"	2 3/8"	2 13/16"	5 9/16"	1 1/8"	2 1/2"	9/16"	1 3/4"

## Three Way Valves / One Pressure Connection

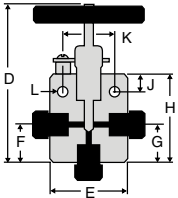

Tubing	Catalog No.	psi	Connection	Orifice	D	E	F	G	H	J	K	L	Thickness
1/8" O.D.	30-14HF2	30,000	HF2	1/16"	3 1/4"	1 1/2"	1 5/16"	1 5/16"	1 13/16"	5/16"	7/8"	9/64"	3/4"
1/4" O.D.	30-14HF4	30,000	HF4	3/32"	5 3/16"	2"	1"	1"	2 7/16"	1/2"	1 3/8"	7/32"	1"
3/8" O.D.	30-14HF6	30,000	HF6	1/8"	5 9/16"	2"	2"	1 7/16"	2 13/16"	1/2"	1 3/8"	7/32"	1"
9/16" O.D.	30-14HF9	30,000	HF9	1/8"	5 5/8"	2 5/8"	2 3/16"	1 7/16"	2 7/8"	1/2"	1 3/8"	7/32"	1 1/2"
1" O.D.	30-14HF16	30,000	HF16	7/16"	9 1/32"	4 1/8"	2 3/8"	2 3/8"	5 1/8"	1 1/8"	2 1/2"	9/16"	1 3/4"

## Three Way / Two Stem Connection Valves

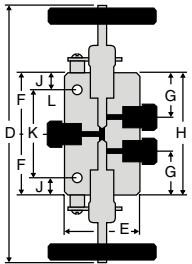

Tubing	Catalog No.	psi	Connection	Orifice	D	E	F	G	H	J	K	L	Thickness
1/8" O.D.	30-15HF2	30,000	HF2	1/16"	5 1/4"	1 1/2"	1 5/16"	7/8"	2 1/2"	5/16"	1 7/8"	9/64"	3/4"
1/4" O.D.	30-15HF4	30,000	HF4	3/32"	9 1/4"	2"	1"	1 7/16"	3 3/4"	1/2"	2 3/4"	7/32"	1"
3/8" O.D.	30-15HF6	30,000	HF6	1/8"	9 1/2"	2"	2"	1 7/16"	4"	1/2"	3"	7/32"	1"
9/16" O.D.	30-15HF9	30,000	HF9	1/8"	9 7/8"	2 5/8"	2 3/16"	1 7/16"	4 3/8"	1/2"	3 3/8"	7/32"	1 1/2"
1" O.D.	30-15HF16	30,000	HF16	7/16"	11 13/16"	4 1/8"	3 7/8"	2 3/4"	7 3/4"	1 1/8"	2 1/2"	9/16"	1 3/4"

## Replaceable Seat Valves

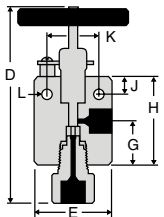

Tubing	Catalog No.	psi	Connection	Orifice	D	E	F	G	H	J	K	L	Thickness
1/4" O.D.	30-12HF4-R	30,000	HF4	3/32"	6"	2"	—	1"	2 7/16"	1/2"	1 3/8"	7/32"	1"
3/8" O.D.	30-12HF6-R	30,000	HF6	1/8"	6 5/8"	2"	—	1 3/8"	2 13/16"	1/2"	1 3/8"	7/32"	1"
9/16" O.D.	30-12HF9-R	30,000	HF9	1/8"	6 13/16"	2 5/8"	—	1 7/16"	2 7/8"	1/2"	1 3/8"	7/32"	1 1/2"
1" O.D.	30-12HF16-R	30,000	HF16	7/16"	10 7/8"	4 1/8"	—	2 3/8"	5 1/8"	1 1/8"	2 1/2"	9/16"	1 3/4"



## High Pressure Equipment

### 40,000 psi High Pressure Valves

**High Pressure (coned & threaded)** type connections for  $\frac{9}{16}$ " O.D. tubing.

**Non-rotating tip stems** are standard for on-off service and insure long life on valve seats. Regulating tip stems are available for all valves at no additional cost, add - REG to part number.

**Glands and collars** for tubing are supplied with each valve unless otherwise requested (glands and collars shown on pages 4.6 and 4.A).

**Materials** include high tensile type 316 stainless steel bodies and hardened 17-4PH stainless steel lower section stems.

**Packing set** consists of multiple Teflon packing with nylon back up, with optional Viton (350°F), BUNA-N (200°F) and Grafoil (800°F) available at no additional cost.

**Air operators** for remote control operation are available for all valves. (Select required valve and add "HIPCO". Refer to section 7.0 for additional data).

**High temperatures** can be accommodated using extended stuffing boxes (see page 6.6).

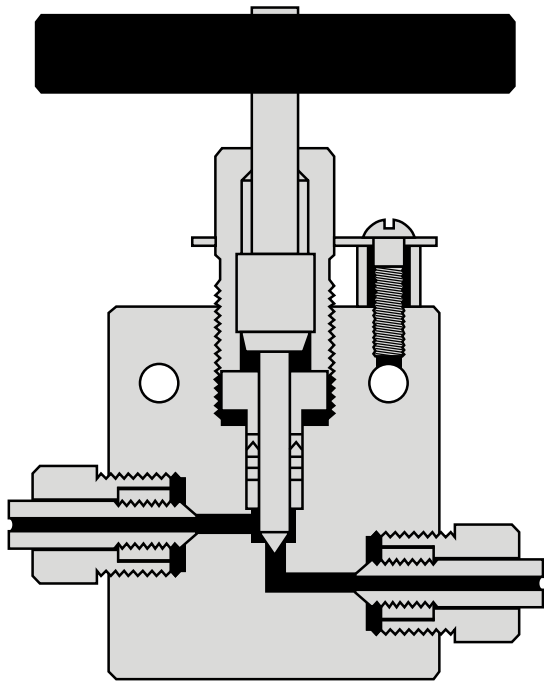

#### Valve Features

- Non-rotating stem tips
- Packing below stem threads
- Type 316 ss high tensile bodies
- Positive gland lock device
- No stem adjustment needed
- Black T-handles or choice of 4 colors

# 40,000 psi High Pressure Valves

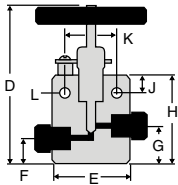

## Two Way Straight Valves

Tubing	Catalog No.	psi	Connection	Orifice	D	E	F	G	H	J	K	L	Thickness
9/16" O.D.	40-11HF9	40,000	HF9	1/8"	5 5/8"	2 5/8"	1"	1 7/16"	2 7/8"	1/2"	1 5/8"	7/32"	1 1/2"

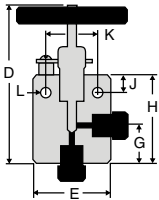

## Two Way Angle Valves

Tubing	Catalog No.	psi	Connection	Orifice	D	E	F	G	H	J	K	L	Thickness
9/16" O.D.	40-12HF9	40,000	HF9	1/8"	5 5/8"	2 5/8"	—	1 7/16"	2 7/8"	1/2"	1 5/8"	7/32"	1 1/2"

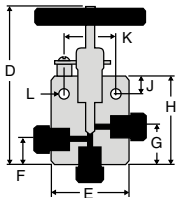

## Three Way Valves / Two Pressure Connections

Tubing	Catalog No.	psi	Connection	Orifice	D	E	F	G	H	J	K	L	Thickness
9/16" O.D.	40-13HF9	40,000	HF9	1/8"	6 1/16"	2 5/8"	1 7/16"	1 7/8"	3 5/16"	1/2"	1 5/8"	7/32"	1 1/2"

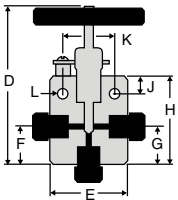

## Three Way Valves / One Pressure Connection

Tubing	Catalog No.	psi	Connection	Orifice	D	E	F	G	H	J	K	L	Thickness
9/16" O.D.	40-14HF9	40,000	HF9	1/8"	5 5/8"	2 5/8"	1 7/16"	1 7/8"	2 7/8"	1/2"	1 5/8"	7/32"	1 1/2"

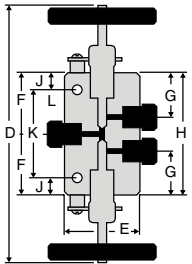

## Three Way / Two Stem Connection Valves

Tubing	Catalog No.	psi	Connection	Orifice	D	E	F	G	H	J	K	L	Thickness
9/16" O.D.	40-15HF9	40,000	HF9	1/8"	9 7/8"	2 5/8"	2 3/16"	1 7/16"	4 3/8"	1/2"	3 3/8"	7/32"	1 1/2"

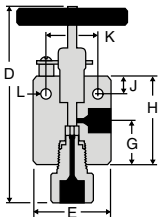

## Replaceable Seat Valves

Tubing	Catalog No.	psi	Connection	Orifice	D	E	F	G	H	J	K	L	Thickness
9/16" O.D.	40-12HF9-R	40,000	HF9	1/8"	6 3/8"	2 5/8"	—	1 7/16"	2 7/8"	1/2"	1 5/8"	7/32"	1 1/2"



## High Pressure Equipment

### 60,000 psi High Pressure Valves

**High Pressure (coned & threaded)** type connections for  $\frac{1}{8}$ ",  $\frac{1}{4}$ ",  $\frac{3}{8}$ ",  $\frac{9}{16}$ " and 1" O.D. tubing.

**Non-rotating tip stems** are standard for on-off service and insure long life on valve seats. Regulating tip stems are available for all valves at no additional cost, add - REG to part number.

**Glands and collars** for tubing are supplied with each valve unless otherwise requested (glands and collars shown on pages 4.6 and 4.A).

**Materials** include high tensile type 316 stainless steel bodies and hardened 17-4PH stainless steel lower section stems.

**Packing set** consists of multiple Teflon packing with nylon back up, with optional Viton (350°F), BUNA-N (200°F) and Grafoil (800°F) available at no additional cost.

**Air operators** for remote control operation are available for all valves. (Select required valve and add "HIPCO". Refer to section 7.0 for additional data).

**High temperatures** can be accommodated using extended stuffing boxes (see page 6.6). These are available for all sizes except  $\frac{1}{8}$ " tubing.

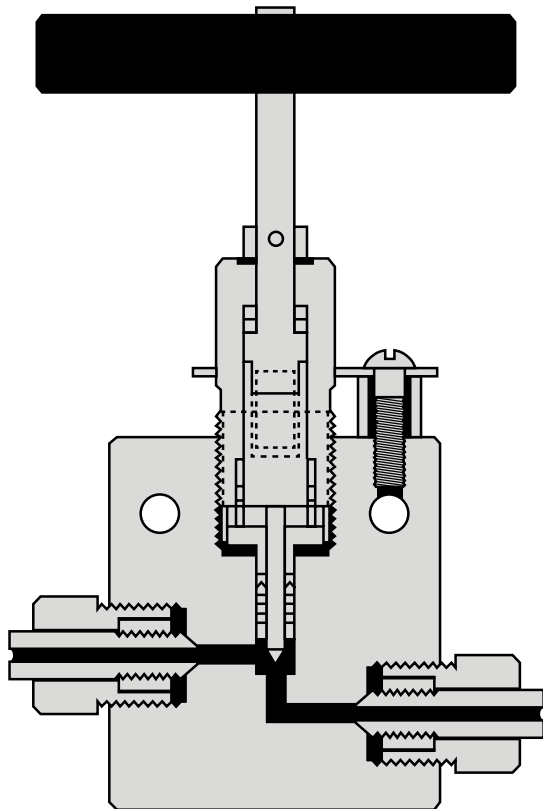

#### Valve Features

- Non-rotating stem tips
- Packing below stem threads
- Type 316 ss high tensile bodies
- Positive gland lock device
- No stem adjustment needed
- Black T-handles or choice of 4 colors
- Tube sizes  $\frac{1}{8}$ " through  $\frac{9}{16}$ "

# 60,000 psi High Pressure Valves

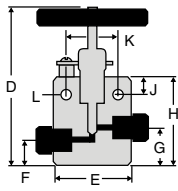

## Two Way Straight Valves

Tubing	Catalog No.	psi	Connection	Orifice	D	E	F	G	H	J	K	L	Thickness
1/8" O.D.	60-11HF2	60,000	HF2	1/16"	5 <sup>3</sup> / <sub>16</sub> "	2"	5/8"	1 <sup>5</sup> / <sub>16</sub> "	2 <sup>7</sup> / <sub>16</sub> "	1/2"	1 <sup>3</sup> / <sub>8</sub> "	7/32"	1"
1/4" O.D.	60-11HF4	60,000	HF4	1/16"	5 <sup>3</sup> / <sub>16</sub> "	2"	5/8"	1"	2 <sup>7</sup> / <sub>16</sub> "	1/2"	1 <sup>3</sup> / <sub>8</sub> "	7/32"	1"
3/8" O.D.	60-11HF6	60,000	HF6	1/16"	5 <sup>3</sup> / <sub>16</sub> "	2"	5/8"	1"	2 <sup>7</sup> / <sub>16</sub> "	1/2"	1 <sup>3</sup> / <sub>8</sub> "	7/32"	1"
9/16" O.D.	60-11HF9	60,000	HF9	1/16"	5 <sup>5</sup> / <sub>8</sub> "	2 <sup>5</sup> / <sub>8</sub> "	1"	1 <sup>7</sup> / <sub>16</sub> "	2 <sup>7</sup> / <sub>8</sub> "	1/2"	1 <sup>3</sup> / <sub>8</sub> "	7/32"	1 <sup>1</sup> / <sub>2</sub> "

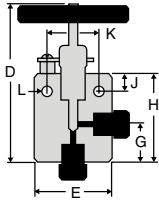

## Two Way Angle Valves

Tubing	Catalog No.	psi	Connection	Orifice	D	E	F	G	H	J	K	L	Thickness
1/8" O.D.	60-12HF2	60,000	HF2	1/16"	5 <sup>3</sup> / <sub>16</sub> "	2"	—	1"	2 <sup>7</sup> / <sub>16</sub> "	1/2"	1 <sup>3</sup> / <sub>8</sub> "	7/32"	1"
1/4" O.D.	60-12HF4	60,000	HF4	1/16"	5 <sup>3</sup> / <sub>16</sub> "	2"	—	1"	2 <sup>7</sup> / <sub>16</sub> "	1/2"	1 <sup>3</sup> / <sub>8</sub> "	7/32"	1"
3/8" O.D.	60-12HF6	60,000	HF6	1/16"	5 <sup>3</sup> / <sub>16</sub> "	2"	—	1 <sup>3</sup> / <sub>8</sub> "	2 <sup>13</sup> / <sub>16</sub> "	1/2"	1 <sup>3</sup> / <sub>8</sub> "	7/32"	1"
9/16" O.D.	60-12HF9	60,000	HF9	1/16"	5 <sup>5</sup> / <sub>8</sub> "	2 <sup>5</sup> / <sub>8</sub> "	—	1 <sup>7</sup> / <sub>16</sub> "	2 <sup>7</sup> / <sub>8</sub> "	1/2"	1 <sup>3</sup> / <sub>8</sub> "	7/32"	1 <sup>1</sup> / <sub>2</sub> "

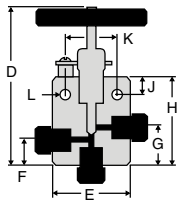

## Three Way Valves / Two Pressure Connections

Tubing	Catalog No.	psi	Connection	Orifice	D	E	F	G	H	J	K	L	Thickness
1/8" O.D.	60-13HF2	60,000	HF2	1/16"	5 <sup>3</sup> / <sub>16</sub> "	2"	5/8"	1"	2 <sup>7</sup> / <sub>16</sub> "	1/2"	1 <sup>3</sup> / <sub>8</sub> "	7/32"	1"
1/4" O.D.	60-13HF4	60,000	HF4	1/16"	5 <sup>3</sup> / <sub>16</sub> "	2"	5/8"	1"	2 <sup>7</sup> / <sub>16</sub> "	1/2"	1 <sup>3</sup> / <sub>8</sub> "	7/32"	1"
3/8" O.D.	60-13HF6	60,000	HF6	1/16"	5 <sup>3</sup> / <sub>16</sub> "	2"	1"	1 <sup>3</sup> / <sub>8</sub> "	2 <sup>13</sup> / <sub>16</sub> "	1/2"	1 <sup>3</sup> / <sub>8</sub> "	7/32"	1"
9/16" O.D.	60-13HF9	60,000	HF9	1/16"	6 <sup>1</sup> / <sub>16</sub> "	2 <sup>5</sup> / <sub>8</sub> "	1 <sup>7</sup> / <sub>16</sub> "	1 <sup>7</sup> / <sub>8</sub> "	3 <sup>5</sup> / <sub>16</sub> "	1/2"	1 <sup>3</sup> / <sub>8</sub> "	7/32"	1 <sup>1</sup> / <sub>2</sub> "

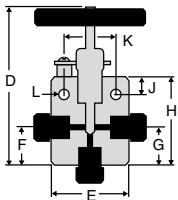

## Three Way Valves / One Pressure Connection

Tubing	Catalog No.	psi	Connection	Orifice	D	E	F	G	H	J	K	L	Thickness
1/8" O.D.	60-14HF2	60,000	HF2	1/16"	5 <sup>3</sup> / <sub>16</sub> "	2"	7/8"	1/2"	2 <sup>7</sup> / <sub>16</sub> "	1/2"	1 <sup>3</sup> / <sub>8</sub> "	7/32"	1"
1/4" O.D.	60-14HF4	60,000	HF4	1/16"	5 <sup>3</sup> / <sub>16</sub> "	2"	1"	1"	2 <sup>7</sup> / <sub>16</sub> "	1/2"	1 <sup>3</sup> / <sub>8</sub> "	7/32"	1"
3/8" O.D.	60-14HF6	60,000	HF6	1/16"	5 <sup>3</sup> / <sub>16</sub> "	2"	1 <sup>3</sup> / <sub>8</sub> "	1 <sup>3</sup> / <sub>8</sub> "	2 <sup>13</sup> / <sub>16</sub> "	1/2"	1 <sup>3</sup> / <sub>8</sub> "	7/32"	1"
9/16" O.D.	60-14HF9	60,000	HF9	1/16"	5 <sup>5</sup> / <sub>8</sub> "	2 <sup>5</sup> / <sub>8</sub> "	1 <sup>7</sup> / <sub>16</sub> "	1 <sup>7</sup> / <sub>16</sub> "	2 <sup>7</sup> / <sub>8</sub> "	1/2"	1 <sup>3</sup> / <sub>8</sub> "	7/32"	1 <sup>1</sup> / <sub>2</sub> "

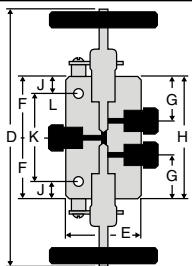

## Three Way / Two Stem Connection Valves

Tubing	Catalog No.	psi	Connection	Orifice	D	E	F	G	H	J	K	L	Thickness
1/8" O.D.	60-15HF2	60,000	HF2	1/16"	9 <sup>1</sup> / <sub>4</sub> "	2"	1 <sup>7</sup> / <sub>8</sub> "	1 <sup>7</sup> / <sub>16</sub> "	3 <sup>3</sup> / <sub>4</sub> "	1/2"	2 <sup>3</sup> / <sub>4</sub> "	7/32"	1"
1/4" O.D.	60-15HF4	60,000	HF4	1/16"	9 <sup>1</sup> / <sub>4</sub> "	2"	1 <sup>7</sup> / <sub>8</sub> "	1 <sup>7</sup> / <sub>16</sub> "	3 <sup>3</sup> / <sub>4</sub> "	1/2"	2 <sup>3</sup> / <sub>4</sub> "	7/32"	1"
3/8" O.D.	60-15HF6	60,000	HF6	1/16"	9 <sup>1</sup> / <sub>2</sub> "	2"	2"	1 <sup>7</sup> / <sub>16</sub> "	4"	1/2"	3"	7/32"	1"
9/16" O.D.	60-15HF9	60,000	HF9	1/16"	9 <sup>7</sup> / <sub>8</sub> "	2 <sup>5</sup> / <sub>8</sub> "	2 <sup>3</sup> / <sub>16</sub> "	1 <sup>7</sup> / <sub>16</sub> "	4 <sup>3</sup> / <sub>8</sub> "	1/2"	3 <sup>3</sup> / <sub>8</sub> "	7/32"	1 <sup>1</sup> / <sub>2</sub> "

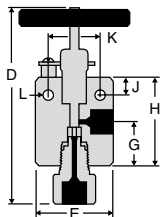

## Replaceable Seat Valves

Tubing	Catalog No.	psi	Connection	Orifice	D	E	F	G	H	J	K	L	Thickness
1/4" O.D.	60-12HF4-R	60,000	HF4	1/16"	6"	2"	—	1"	2 <sup>7</sup> / <sub>16</sub> "	1/2"	1 <sup>3</sup> / <sub>8</sub> "	7/32"	1"
3/8" O.D.	60-12HF6-R	60,000	HF6	1/16"	6 <sup>5</sup> / <sub>8</sub> "	2"	—	1 <sup>3</sup> / <sub>8</sub> "	2 <sup>13</sup> / <sub>16</sub> "	1/2"	1 <sup>3</sup> / <sub>8</sub> "	7/32"	1"
9/16" O.D.	60-12HF9-R	60,000	HF9	1/16"	6 <sup>13</sup> / <sub>16</sub> "	2 <sup>5</sup> / <sub>8</sub> "	—	1 <sup>7</sup> / <sub>16</sub> "	2 <sup>7</sup> / <sub>8</sub> "	1/2"	1 <sup>3</sup> / <sub>8</sub> "	7/32"	1 <sup>1</sup> / <sub>2</sub> "



## High Pressure Equipment

### Glands/Sleeves/Plugs/Elbows/Tees/Crosses

A complete range of elbows, tees, and crosses is available for all of the tubing connection sizes. Material is high tensile 316 stainless steel. Standard tubing glands and collars are provided unless otherwise specified.

#### Connection Components

Catalog No.	Tube Size	Gland	Catalog No.	Tube Size	Collar	Catalog No.	Tube Size	Plug
60-2HM2	1/8"		60-2H2	1/8"		60-7HM2	1/8"	
60-2HM4	1/4"		60-2H4	1/4"		60-7HM4	1/4"	
60-2HM6	3/8"		60-2H6	3/8"		60-7HM6	3/8"	
60-2HM9	9/16"		60-2H9	9/16"		60-7HM9	9/16"	
40-2HM9	9/16"		40-2H9	9/16"		40-7HM9	9/16"	
30-2HM16	1"		30-2H16	1"		30-7HM16	1"	

#### High Pressure Elbows

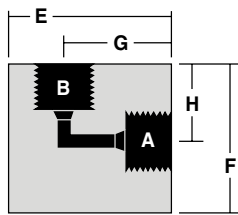

Catalog No.	Pressure Rating psi	Connections	A-B	E	F	G	H	Thickness
60-22HF2	60,000	1/8" O.D. TUBE	HF2	1 1/8"	1 1/8"	3/4"	3/4"	3/4"
60-22HF4	60,000	1/4" O.D. TUBE	HF4	1 3/8"	1 1/2"	7/8"	1"	1"
60-22HF6	60,000	3/8" O.D. TUBE	HF6	1 3/4"	1 1/2"	1 1/4"	1"	1"
60-22HF9	60,000	9/16" O.D. TUBE	HF9	2 5/8"	1 7/8"	1 7/8"	1 1/8"	1 1/2"
40-22HF9	40,000	9/16" O.D. TUBE	HF9	2 5/8"	1 7/8"	1 7/8"	1 1/8"	1 1/2"
30-22HF16	30,000	1" O.D. TUBE	HF16	3"	3"	2 1/16"	2 1/16"	1 3/4"

#### High Pressure Tees

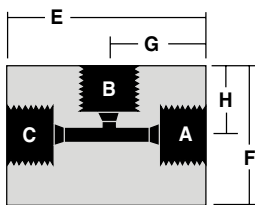

Catalog No.	Pressure Rating psi	Connections	A-B-C	E	F	G	H	Thickness
60-23HF2	60,000	1/8" O.D. TUBE	HF2	1 1/2"	1 1/8"	3/4"	3/4"	3/4"
60-23HF4	60,000	1/4" O.D. TUBE	HF4	2"	1 3/8"	1"	7/8"	1"
60-23HF6	60,000	3/8" O.D. TUBE	HF6	2"	1 9/16"	1"	1 1/16"	1"
60-23HF9	60,000	9/16" O.D. TUBE	HF9	2 5/8"	2 1/8"	1 5/16"	1 3/8"	1 1/2"
40-23HF9	40,000	9/16" O.D. TUBE	HF9	2 5/8"	2 1/8"	1 5/16"	1 3/8"	1 1/2"
30-23HF16	30,000	1" O.D. TUBE	HF16	4 1/8"	3"	2 1/16"	2 1/16"	1 3/4"

#### High Pressure Crosses

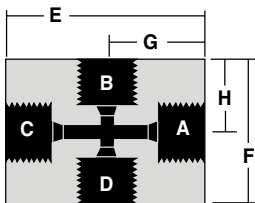

Catalog No.	Pressure Rating psi	Connections	A-B-C-D	E	F	G	H	Thickness
60-24HF2	60,000	1/8" O.D. TUBE	HF2	1 1/2"	1 1/2"	3/4"	3/4"	3/4"
60-24HF4	60,000	1/4" O.D. TUBE	HF4	2"	1 1/2"	1"	3/4"	1"
60-24HF6	60,000	3/8" O.D. TUBE	HF6	2 1/8"	2"	1 1/16"	1"	1"
60-24HF9	60,000	9/16" O.D. TUBE	HF9	2 3/4"	2 5/8"	1 3/8"	1 5/16"	1 1/2"
40-24HF9	40,000	9/16" O.D. TUBE	HF9	2 3/4"	2 5/8"	1 3/8"	1 5/16"	1 1/2"
30-24HF16	30,000	1" O.D. TUBE	HF16	4 1/8"	4 1/8"	2 1/16"	2 1/16"	1 3/4"

# Union Couplings (Slip Type)

Union (slip type) couplings are ideal for use in confined space installations. This design allows the entire coupling to be disconnected and slipped back over the tubing to facilitate assembly and disassembly. In installations where tubing is easily assembled, it is preferable (and less expensive) to use standard straight couplings (see accessories section). Standard material is high tensile 316 stainless steel. Standard tubing collars and glands are provided unless otherwise specified.

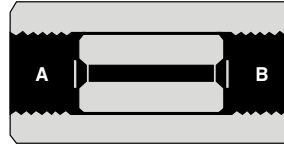

Catalog No.	Pressure Rating psi	Connections	A	B	Length	Hex Size
60-21HF2-U	60,000	1/8" O.D. TUBING	HF2	HF2	1 1/8"	3/4"
60-21HF4-U	60,000	1/4" O.D. TUBING	HF4	HF4	1 3/4"	1"
60-21HF6-U	60,000	3/8" O.D. TUBING	HF6	HF6	2"	1"
60-21HF9-U	60,000	9/16" O.D. TUBING	HF9	HF9	2 3/8"	1 3/8"
40-21HF9-U	40,000	9/16" O.D. TUBING	HF9	HF9	2 3/8"	1 3/8"
30-21HF16-U	30,000	1" O.D. TUBING	HF16	HF16	3 1/2"	1 3/4"

# Bulkhead Couplings

Bulkhead couplings are designed specifically for passing a tubing connection through a panel or steel barricade. These couplings include a locknut as shown. Material is high tensile 316 stainless steel. Standard tubing collars and glands are included unless otherwise specified.

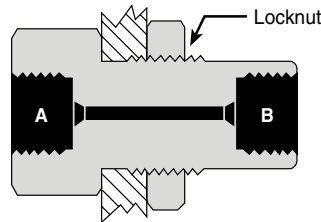

Catalog No.	Pressure Rating psi	Connections	Panel Hole	A	B	Length	Hex Size	Outside Thread
60-21HF2-B	60,000	1/8" O.D. TUBING	15/16"	HF2	HF2	1 13/16"	1"	7/8" - 14
60-21HF4-B	60,000	1/4" O.D. TUBING	15/16"	HF4	HF4	2"	1"	7/8" - 14
60-21HF6-B	60,000	3/8" O.D. TUBING	1 1/16"	HF6	HF6	2 3/8"	1 3/8"	1 1/16" - 12
60-21HF9-B	60,000	9/16" O.D. TUBING	1 11/16"	HF9	HF9	2 3/4"	1 7/8"	1 5/8" - 12
40-21HF9-B	40,000	9/16" O.D. TUBING	1 11/16"	HF9	HF9	2 3/4"	1 7/8"	1 5/8" - 12
30-21HF16-B	30,000	1" O.D. TUBING	1 15/16"	HF16	HF16	3 1/2"	2 1/8"	2 1/8" - 12

# Caps

Tubing end caps are offered for use in sealing off tubing ends either for temporary use or permanent use such as on small volume reservoirs. Standard material is high tensile 316 stainless steel. Standard tubing collars and glands are provided unless otherwise specified.

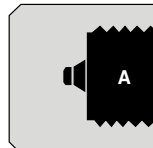

Catalog No.	Pressure Rating psi	Connections	A	Length	Hex Size
60-21HF2-C	60,000	1/8" O.D. TUBING	HF2	7/8"	3/4"
60-21HF4-C	60,000	1/4" O.D. TUBING	HF4	7/8"	3/4"
60-21HF6-C	60,000	3/8" O.D. TUBING	HF6	1 1/4"	1"
60-21HF9-C	60,000	9/16" O.D. TUBING	HF9	1 1/2"	1 3/8"
40-21HF9-C	40,000	9/16" O.D. TUBING	HF9	1 1/2"	1 3/8"
30-21HF16-C	30,000	1" O.D. TUBING	HF16	3"	1 3/4"







# High Pressure Equipment

## Line Filters

The line filters as shown utilize sintered stainless steel filter discs 3 pc./set. Porosities are available as per the chart to the right. If not otherwise specified, 100 micron filter discs are supplied. (One micron = 0.001 millimeters). Material of bodies and end covers is high tensile 316 stainless steel. Standard tubing glands and collars are provided unless otherwise specified.

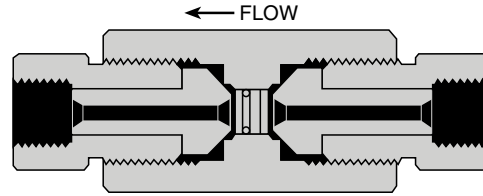

Catalog No.	Pressure Rating psi	Connections	Length	Hex Size	Micron Size Filter Available					
					0.5	2	5	10	40	100
40F-51HF9	40,000	9/16" HIGH PRESSURE	5 3/4"	1 1/2"	●	●	●	●	●	●
60F-51HF2	60,000	1/8" HIGH PRESSURE	4 1/16"	1 1/2"	●	●	●	●	●	●
60F-51HF4	60,000	1/4" HIGH PRESSURE	4 7/8"	1 1/2"	●	●	●	●	●	●
60F-51HF6	60,000	3/8" HIGH PRESSURE	5 1/4"	1 1/2"	●	●	●	●	●	●
60F-51HF9	60,000	9/16" HIGH PRESSURE	5 3/4"	1 1/2"	●	●	●	●	●	●

## Ball Check Valves

Ball type check valves insure flow in one direction only. Material for bodies and covers is 316 stainless steel (30-41HF16 body and cover are 17-4PH). Standard tubing glands and collars are provided unless otherwise specified.

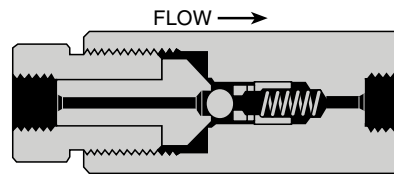

Catalog No.	psi	Connections	Length	Hex
40-41HF9	40,000	9/16" HIGH PRESSURE	5 1/8"	1 1/2"
60-41HF2	60,000	1/8" HIGH PRESSURE	4 3/16"	1 1/2"
60-41HF4	60,000	1/4" HIGH PRESSURE	4 1/4"	1 1/2"
60-41HF6	60,000	3/8" HIGH PRESSURE	4 5/8"	1 1/2"
60-41HF9	60,000	9/16" HIGH PRESSURE	5 1/8"	1 1/2"
30-41HF16	30,000	1" HIGH PRESSURE	6 1/2"	2 1/2" RD with flats

## Soft Seat Check Valves

Soft seat check valves insure flow in one direction only and can be mounted in any position. These are highly reliable for both gas and liquid service. Standard O-ring (soft seat) material for the sealing surface is Buna-N (nitrile) with other materials including Teflon and Viton available on request. Temperature is limited by the choice of O-ring material. Material of all other parts is high tensile 316 stainless steel. (30-41HF16-T body and cover are 17-4PH). Standard glands and collars are provided unless otherwise specified.

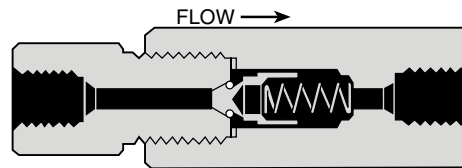

Catalog No.	psi	Connections	Length	Hex
30-41HF2-T	30,000	1/8" HIGH PRESSURE	3 3/4"	1"
30-41HF4-T	30,000	1/4" HIGH PRESSURE	3 7/8"	1"
30-41HF6-T	30,000	3/8" HIGH PRESSURE	3 7/8"	1"
30-41HF9-T	30,000	9/16" HIGH PRESSURE	4 1/4"	1 3/8"
40-41HF9-T	40,000	9/16" HIGH PRESSURE	5 1/16"	1 1/2"
60-41HF4-T	60,000	1/4" HIGH PRESSURE	4 9/16"	1 1/2"
60-41HF6-T	60,000	3/8" HIGH PRESSURE	4 9/16"	1 1/2"
60-41HF9-T	60,000	9/16" HIGH PRESSURE	5 1/16"	1 1/2"
30-41HF16-T	30,000	1" HIGH PRESSURE	6 1/2"	2 1/2" RD with flats



# Excess Surge Check Valves

Excess surge check valves are used to eliminate loss of pressure due to a sudden surge or opening of a pressure component in a pressurized system (such as a breakage of a gauge or test component). These check valves should be mounted in the vertical position. Only one basic size is available (60-41HF9-E) with adapters readily available to convert to other size connections. Standard tubing glands and collars are provided unless otherwise specified.

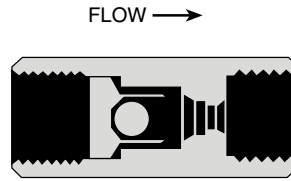

Catalog No.	psi	Connections	LengthH	ex
60-41HF9-E	60,000	9/16" HIGH PRESSURE	3 1/8"	1 1/2"

# Rupture Discs

## 1/4" Angled Seat

Standard rupture discs are available from stock in burst pressures as listed in the chart to the right. These discs are 316 stainless steel (except for 1000 psi which are inconel) and may be used with any of the safety heads shown. Note that these rupture discs are manufactured with a tolerance of plus 6% and minus 3% of specified burst pressure. Samples of each batch are then tested and the actual average burst pressure is stamped on the accompanying metal tag. Factors influencing rupture disc life include corrosion, metal fatigue, and cyclic effect. Periodic replacement is recommended to prevent premature failure. It is recommended that working pressure does not exceed 70% of burst rating for maximum life cycle of the disc.

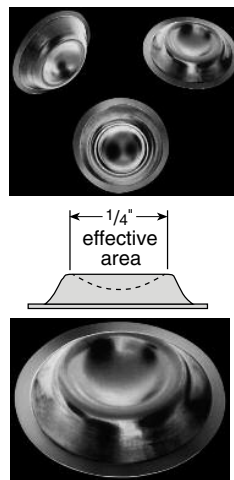

**SPECIAL DISCS** are available on special order for pressure ranges not shown above and in numerous materials and coatings. Consult factory for price and delivery.

### Standard Burst Pressures (in psi at 72°F)

1,000	3,000	5,000	7,000	9,000	11,000	17,500	25,000	37,500	55,000
1,500	3,500	5,500	7,500	9,500	11,500	18,000	27,000	40,000	60,000
2,000	4,000	6,000	8,000	10,000	12,500	20,000	30,000	45,000	65,000
2,500	4,500	6,500	8,500	10,500	15,000	22,500	35,000	50,000	



## High Pressure Equipment

### Safety Heads

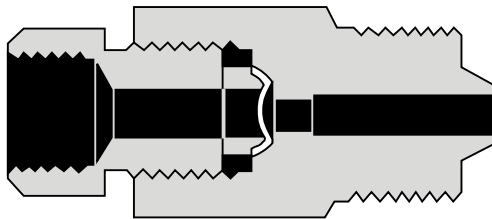

A choice of three safety head designs is available, male inlet, female inlet (straight), and tee type. The male inlet design can be inserted directly into the tubing connections of valves and various fittings such as tees and crosses, or located in pressure vessels.

Outlet connections on all sizes are  $\frac{3}{8}$ " pipe (NPT). This outlet may be connected to a suitable discharge line to vent pressure to a safe location in the event of bursting of the rupture disc. Torque required for sealing rupture discs will range from 40 to 90 foot pounds, depending upon pressure and media being used.

Material of bodies and hold down nuts is high tensile 316 stainless steel. Standard tubing glands and collars are provided unless otherwise specified.

**Note:** Rupture discs are **not** included and must be ordered as a separate item.



#### Male Inlet Safety Heads

Catalog No.	Pressure Rating psi	Inlet Connection	Length	Hex Size
60-61HM4	60,000	$\frac{1}{4}$ " HIGH PRESSURE	$1\frac{7}{8}$ "	$1\frac{1}{8}$ "
60-61HM6	60,000	$\frac{3}{8}$ " HIGH PRESSURE	$2\frac{1}{8}$ "	$1\frac{1}{8}$ "
60-61HM9	60,000	$\frac{9}{16}$ " HIGH PRESSURE	$2\frac{3}{8}$ "	$1\frac{1}{2}$ "
40-61HM9	40,000	$\frac{9}{16}$ " HIGH PRESSURE	$2\frac{3}{8}$ "	$1\frac{1}{2}$ "
30-61HM16	30,000	1" HIGH PRESSURE	$3\frac{1}{2}$ "	$1\frac{1}{8}$ "

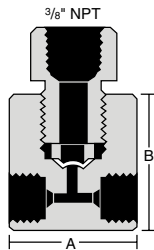

#### Tee Type Safety Heads

Catalog No.	Pressure Rating psi	Inlet Connection	A	B	Thickness
60-63HF2	60,000	$\frac{1}{8}$ " HIGH PRESSURE	$1\frac{1}{2}$ "	$1\frac{3}{4}$ "	1"
60-63HF4	60,000	$\frac{1}{4}$ " HIGH PRESSURE	$1\frac{1}{2}$ "	$1\frac{3}{4}$ "	1"
60-63HF6	60,000	$\frac{3}{8}$ " HIGH PRESSURE	2"	$1\frac{3}{4}$ "	1"
60-63HF9	60,000	$\frac{9}{16}$ " HIGH PRESSURE	$2\frac{5}{8}$ "	2"	$1\frac{1}{2}$ "
40-63HF9	40,000	$\frac{9}{16}$ " HIGH PRESSURE	2"	$2\frac{5}{8}$ "	$1\frac{1}{2}$ "

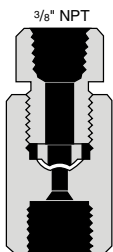

#### Female Inlet (Straight) Safety Heads

Catalog No.	Pressure Rating psi	Inlet Connection	Length	Hex Size
60-61HF2	60,000	$\frac{1}{8}$ " HIGH PRESSURE	$1\frac{7}{8}$ "	$1\frac{1}{8}$ "
60-61HF4	60,000	$\frac{1}{4}$ " HIGH PRESSURE	$1\frac{7}{8}$ "	$1\frac{1}{8}$ "
60-61HF6	60,000	$\frac{3}{8}$ " HIGH PRESSURE	$1\frac{7}{8}$ "	$1\frac{1}{8}$ "
60-61HF9	60,000	$\frac{9}{16}$ " HIGH PRESSURE	$2\frac{7}{8}$ "	$1\frac{1}{2}$ "
40-61HF9	40,000	$\frac{9}{16}$ " HIGH PRESSURE	$2\frac{3}{8}$ "	$1\frac{1}{2}$ "

# Anti-Vibration Gland Assemblies

Tubing systems that are subject to extreme vibration or shock, such as mobile pressure systems or long tubing runs culminating at a compressor, will benefit from the use of High Pressure Equipment Company's Anti-Vibration Gland Assemblies. These assemblies utilize the same reliable connection geometries as the standard HiP fittings, with the added benefit of essentially unlimited vibrational fatigue life.

A coned and threaded tube, when subjected to unusual or excessive vibration, may fail prematurely and break at the last thread. The Anti-Vibration Gland Assembly acts to move the fulcrum of vibration away from the threaded portion of the tube and onto the strong, solid wall of the tubing. A wedge-like collet firmly holds the assembly in place, virtually eliminating premature tubing failure while reliably maintaining a leak-free connection between the tube and the connection seat.

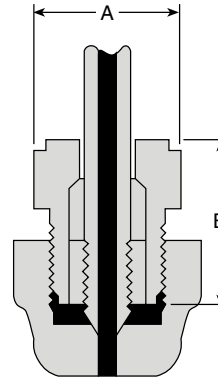

## High Pressure Anti-Vibration Gland Assemblies

Catalog No.	Pressure Rating psi	Connections	AB	
60-3HM4	60,000	1/4" HIGH PRESSURE	5/8"	13/16"
60-3HM6	60,000	3/8" HIGH PRESSURE	13/16"	1 1/8"
60-3HM9	60,000	9/16" HIGH PRESSURE	1 13/16"	1 9/16"
40-3HM9	40,000	9/16" HIGH PRESSURE	1 13/16"	1 9/16"

## Anti-Vibration Components

Tubing Size	Slotted C Collet	ollet Gland	Collar
1/4"	2-8784	2-8783	60-2H4
3/8"	2-8786	2-8785	60-2H6
9/16"	2-8788	2-8787	60-2H9



## High Pressure Equipment

### High Pressure Tubing

Tubing is cold drawn, seamless, and is supplied in the  $\frac{1}{8}$ " hard condition (not annealed). Tensile strength is approximately 40 percent higher than that of annealed tubing. All tubing is manufactured in strict accordance with High Pressure Equipment Company specifications to insure tolerances and bore quality. Tubing is stocked in lengths of 18 to 22 feet but may be ordered in shorter lengths with **no additional cutting charge**.

**Note:** The  $\frac{1}{8}$ " O.D. tubing sizes may be coiled for shipment. Larger sizes must be shipped in straight lengths.

	Tubing Size	Working Pressure psi	Type of Connection Used	Material	Catalog Order Number
<b><math>\frac{1}{8}</math>"</b>	$\frac{1}{8}$ " O.D. x 0.020" I.D.	60,000	$\frac{1}{8}$ " HIGH PRESSURE (HF2)	316 SS	60-9H2
	$\frac{1}{8}$ " O.D. x 0.040" I.D.	30,000	$\frac{1}{8}$ " HIGH PRESSURE (HF2)	316 SS	30-9H2
<b><math>\frac{1}{4}</math>"</b>	$\frac{1}{4}$ " O.D. x 0.083" I.D.	60,000	$\frac{1}{4}$ " HIGH PRESSURE (HF4)	316 SS *	60-9H4-316
				304 SS *	60-9H4-304
<b><math>\frac{3}{8}</math>"</b>	$\frac{3}{8}$ " O.D. x $\frac{1}{8}$ " I.D.	60,000	$\frac{3}{8}$ " HIGH PRESSURE (HF6)	316 SS	60-9H6-316
				304 SS	60-9H6-304
<b><math>\frac{9}{16}</math>"</b>	$\frac{9}{16}$ " O.D. x $\frac{3}{16}$ " I.D.	60,000	$\frac{9}{16}$ " HIGH PRESSURE (HF9)	316 SS	60-9H9-316
				304 SS	60-9H9-304
<b><math>\frac{9}{16}</math>"</b>	$\frac{9}{16}$ " O.D. x $\frac{1}{4}$ " I.D.	40,000	$\frac{9}{16}$ " HIGH PRESSURE (HF9)	316 SS	40-9H9-316
				304 SS	40-9H9-304
<b>1"</b>	1" O.D. x 0.437" I.D.	30,000	1" HIGH PRESSURE (HF16)	316 SS	30-9H16-316

### Nipples

Nipples as shown below are stocked in Types 304 and 316 Stainless Steel. Nipples in lengths other than those shown are supplied upon request. Nipples are not furnished with collars and glands, unless specified at time of order.

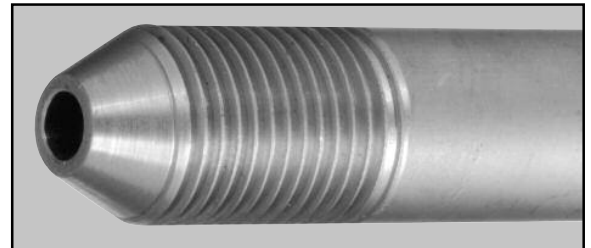

### Coned and Threaded Nipples

Length ↓	Tubing Size (O.D. x I.D.)						
	$\frac{1}{8}$ " x 0.020"	$\frac{1}{8}$ " x 0.040" **	$\frac{1}{4}$ " x 0.083"	$\frac{3}{8}$ " x $\frac{1}{8}$ " *	$\frac{9}{16}$ " x $\frac{1}{4}$ " *	$\frac{9}{16}$ " x $\frac{3}{16}$ " **	1" x 0.437" **
psi →	60,000 psi	30,000 psi	60,000 psi	60,000 psi	40,000 psi	60,000 psi	30,000 psi
2"	60-HM2-2	30-HM2-2					
2 $\frac{3}{4}$ "			60-HM4-2.75				
3"	60-HM2-3	30-HM2-3		60-HM6-3			
4"	60-HM2-4	30-HM2-4			40-HM9-4	60-HM9-4	
6"	60-HM2-6	30-HM2-6	60-HM4-6	60-HM6-6	40-HM9-6	60-HM9-6	30-HM16-6
8"			60-HM4-8	60-HM6-8	40-HM9-8	60-HM9-8	30-HM16-8
9"	60-HM2-9	30-HM2-9					
10"			60-HM4-10	60-HM6-10	40-HM9-10	60-HM9-10	30-HM16-10
12"	60-HM2-12	30-HM2-12	60-HM4-12	60-HM6-12	40-HM9-12	60-HM9-12	30-HM16-12

Specify 316 SS or 304 SS when ordering. \* Also used for 30,000 psi series. \*\* 316 SS

# High Pressure Connections

(Coned and Threaded) 30,000/40,000/60,000 psi service

The High Pressure tubing connection is available for 1/8", 1/4", 3/8", 9/16" and 1" O.D. tubing. The tubing may be prepared with the use of tooling (see tooling section 9.0) or prepared at the factory to specified lengths. Additionally, standard length coned and threaded tubing nipples are available from stock (see page 4.12).

This connection has become an industry standard for use at elevated pressures and temperatures in both liquid and gas applications. It may be disassembled and retightened indefinitely.

The threads of the gland are right-hand while the threads of the collar and tubing are left-hand to prevent rotation of the collar during assembly.

## Materials

All of the components required for make-up of a High Pressure connection (glands, collars and plugs) are produced in Type 316 stainless steel.

Glands and collars are provided with all valves and fittings (except nipples) unless otherwise requested. (See chart on the right for size details and catalog numbers).

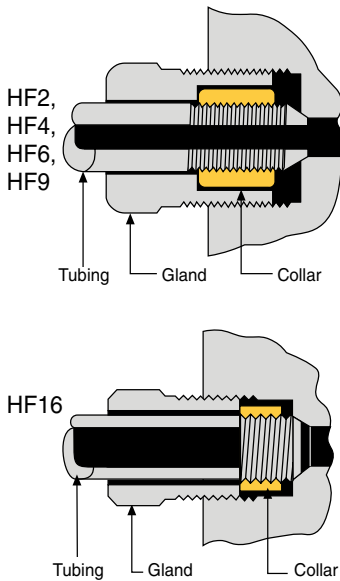

30,000 & 60,000 psi				40,000 psi	30,000 psi
HF2 1/8" O.D. Tubing	HF4 1/4" O.D. Tubing	HF6 3/8" O.D. Tubing	HF9 9/16" O.D. Tubing	HF9 9/16" O.D. Tubing	HF16 1" O.D. Tubing
<b>Female Opening Detail</b>					
HF2	HF4	HF6	HF9	HF9	HF16
<b>Gland</b>					
60-2HM2	60-2HM4	60-2HM6	60-2HM9	60-2HM9	30-2HM16
<b>Collar</b>					
60-2H2	60-2H4	60-2H6	60-2H9	60-2H9	30-2H16
<b>Plug</b>					
60-7HM2	60-7HM4	60-7HM6	60-7HM9	40-7HM9	30-7HM16
<b>Tube End Prep</b>					
HM2	HM4	HM6	HM9	HM9	HM16

# PETROMETALIC



## **Siège social**

32 rue de l'Ermitage  
78000 VERSAILLES  
Tél : +33 1 39 23 96 70  
Fax : +33 1 39 23 96 71



## **Petrometalic Cambrai**

Rue des Ecluses de Selles  
BP 287  
59400 Cambrai Cedex  
Tél : +33 3 27 72 06 60  
Fax : +33 3 27 72 06 61

[www.petrometalic.com](http://www.petrometalic.com)

[negoceversailles@petrometalic.com](mailto:negoceversailles@petrometalic.com)

[negocecambrai@petrometalic.com](mailto:negocecambrai@petrometalic.com)